

PŮDORYS  
M 1:150

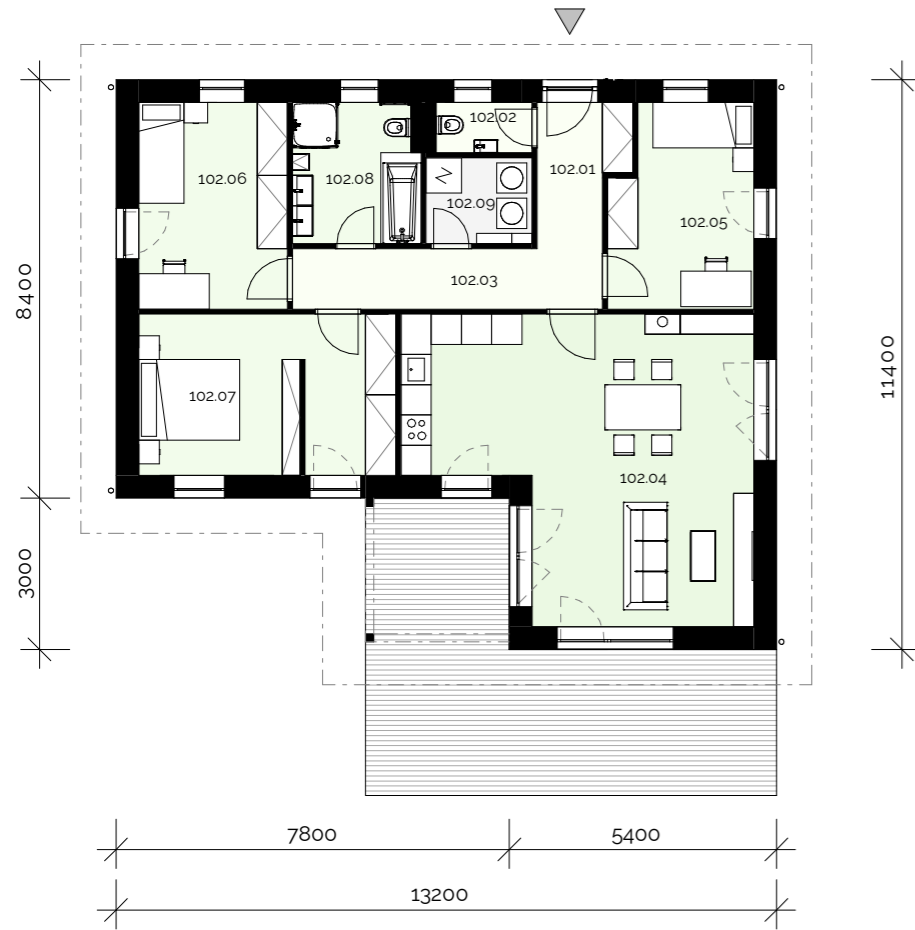

102.01	zádveří	4.85 m <sup>2</sup>
102.02	WC	1.98 m <sup>2</sup>
102.03	chodba	7.83 m <sup>2</sup>
102.04	obývací prostor + KK	37.21 m <sup>2</sup>
102.05	pracovna	11.21 m <sup>2</sup>
102.06	pokoj	12.31 m <sup>2</sup>
102.07	ložnice se šatnou	16.53 m <sup>2</sup>
102.08	koupelna	6.94 m <sup>2</sup>
102.09	TM	3.61 m <sup>2</sup>
UŽITNÁ PLOCHA CELKEM:		102.47 m <sup>2</sup>

UMÍSTĚNÍ NA POZEMKU  
M 1:500

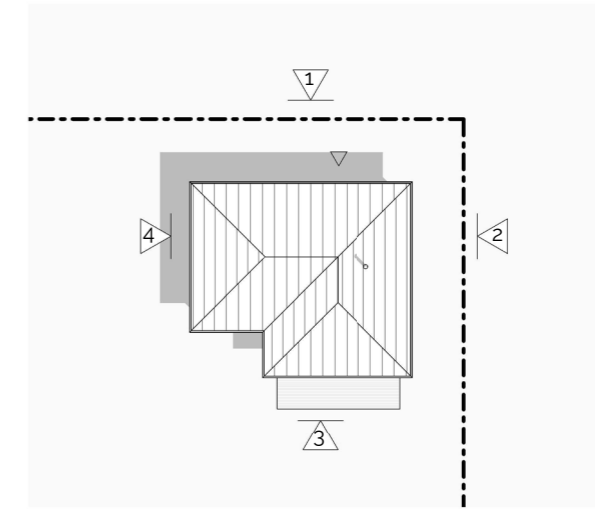
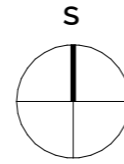

POHLEDY  
M 1:150

01



02

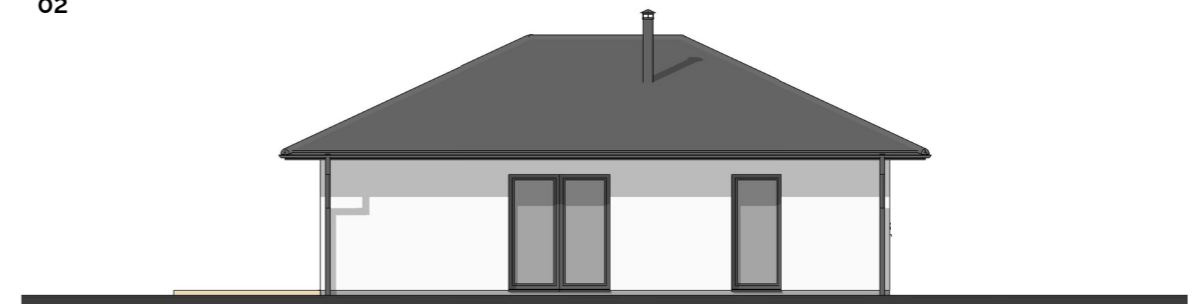

03

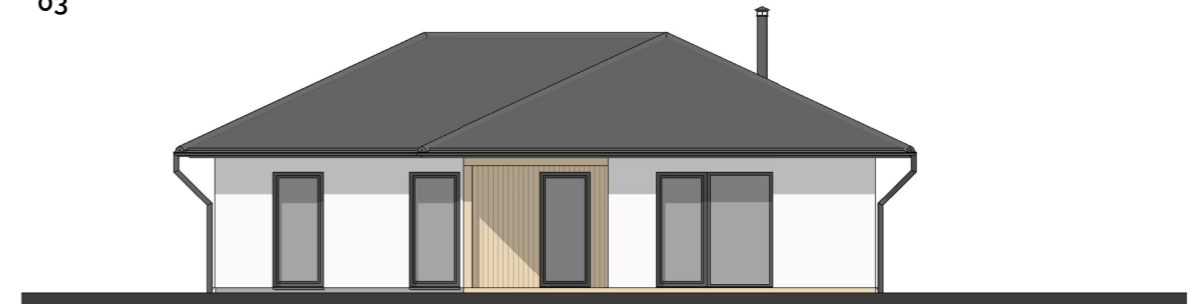

04

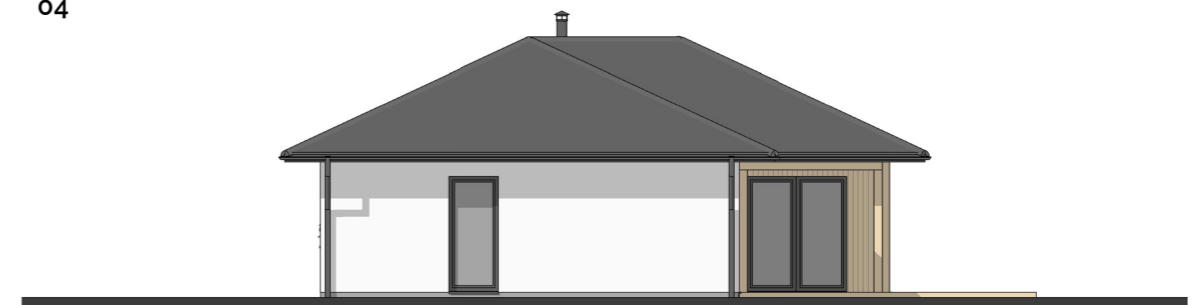

3D ZOBRAZENÍ 1

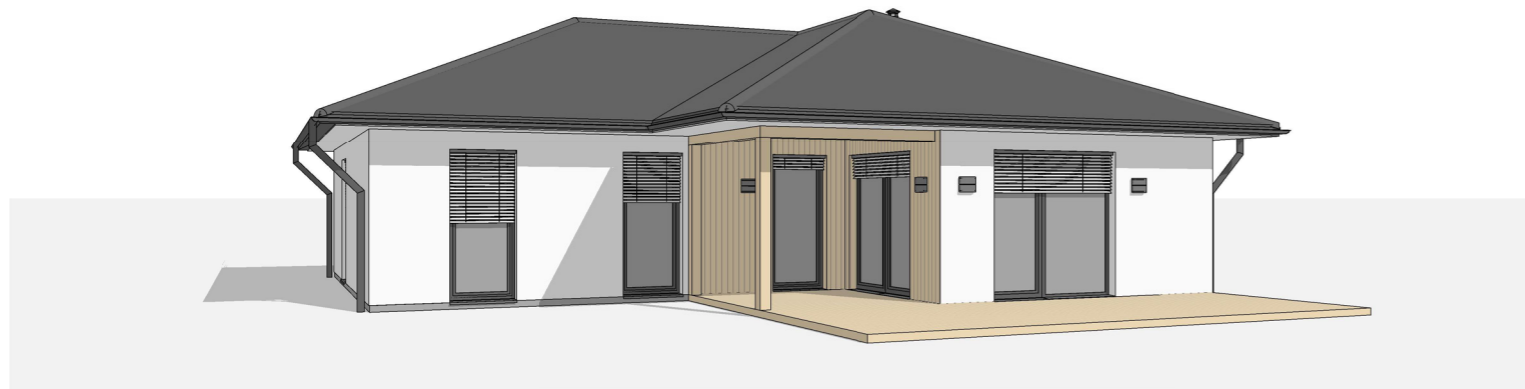

3D ZOBRAZENÍ 2





Concept 102